

Service Bulletin

Machinery Affected: Horizontal Stacker
Document: SB208-D rev. A
Title: Replacing the PLC and Touch Screen Monitor
Applies To: All PLCs Prior to RX3i
Distribution: Customers Upon Order



Copyright © 2016 MiTek®. All rights reserved.

MiTek Machinery Division
301 Fountain Lakes Industrial Drive
St. Charles, MO 63301
Phone: 800-523-3380
www.mii.com

Part # and Rev.	SB208-D rev. A
Revision Date	29 Sept. 2016
Revised By	G. Gaia
Approved By	V. Carroll
Print Date	30 September 2016
Orig Date Created	16 Sept. 2016
Created By	G. Gaia
Applicability	Prior to 90436i

Purpose and Scope

As of the date on the title page, the previous PLC CPU and touch screen monitor are obsolete. When a PLC CPU or associated components are needed, the RX3i model is now supplied. This procedure describes how to install the new backplane and electrical components needed.

The RX3i system is referred to by the manufacturer as a Programmable Automation Controller, but for the purposes of this equipment, it is still called a PLC.

Overview

This Service Bulletin will first explain how to replace the PLC system. Second, it will explain how to mount a new power supply and Ethernet switch. Third, it will explain how to install the new touch screen monitor.

Note that the work described in this service bulletin should be performed only by a qualified electrician who is familiar with electrical wiring and schematics.

The parts included in this kit are shown in Table 1. Please ensure all parts are present before starting this procedure.

Table 1: Parts in SB208KIT-D

Qty.	Part Description	Part #
1	Ethernet switch	504371
1	Ethernet, CAT5, 10 ft	508937
1	Ethernet, CAT5, 5 ft	508938
1	Power supply 24V	509149
1	RX3i Power supply 120 VAC	519916
1	Backplane for RX3i PLC, 12-slot	519932
1	Touch screen monitor, programmed	92116
1	RX3i PLC, programmed	92281-505

Before beginning the procedure, gather the supplies listed in Table 2.

Table 2: Customer-Supplied Items

Lockout/tagout mechanism	Phillips and slotted screwdriver sets
Masking tape and marker	Jig saw
Fine-tooth jigsaw blade for metal	

If you have any questions, call MiTek Machinery Division Customer Service at 800-523-3380.



Procedure

Preparing the Stacker for Shutdown

Before shutting down the Horizontal Stacker, put all stackers in the down position.



Electrical Lockout/Tagout Procedures

 WARNING	
	<p>ELECTROCUTION HAZARD!</p> <p>Verify that all power to the machine has been turned off and follow approved lockout/tagout safety procedures before performing any maintenance.</p> <p>All electrical work must performed by a qualified electrician.</p> <p>If it is absolutely necessary to troubleshoot an energized machine, follow NFPA 70E for proper procedures and personal protective equipment.</p>

When Working on a Machine Inside the Machine’s Main Electrical Enclosure or in the Electrical Transmission Line to the Machine



Before opening the main electrical enclosure, or attempting to repair or replace an electrical transmission line to the machine, lockout/tagout the machine properly. Follow your company’s approved lockout/tagout procedures which should include, but are not limited to the steps here.



1. Engage an E-stop on the machine.
2. Turn the machine’s disconnect switch to the “off” position. This is usually required to open the main electrical enclosure’s door.
3. Shut the power to the machine off at the machine’s power source which is usually an electrical service entry panel on the facility wall. One example of a locked-out power source panel is shown in Figure 1.
4. Attach a lock and tag that meets OSHA requirements for lockout/tagout to the electrical service entry panel.
5. Open the door to the enclosure in which you need access, and using a multimeter, verify that the power is off.

Figure 1: Lockout/Tagout on the Power Source Panel



Hydraulic System Lockout/Tagout Procedure

	 WARNING
	<p>MOVING PARTS CAN CRUSH AND CUT.</p> <p>Always verify that power to the machine has been turned off and follow approved lockout/tagout procedures.</p> <p>Turn off the shutoff valve before performing any maintenance on the equipment.</p>

	 WARNING
	<p>HIGH PRESSURE HAZARD.</p> <p>Bleed hydraulic lines before performing any maintenance on the hydraulic system.</p>

Removing Modules Overview



Care must be exercised when installing and removing modules to avoid damage to the modules and backplane.

To remove any module discussed in this procedure, use these guidelines:

1. Locate the release lever(s) at the bottom of the module and firmly press upward (1), toward the module. Wider modules have two release levers that must both be pressed up at the same time.
2. While holding the module firmly and fully depressing the release levers, pivot the module upward until its connector is out of the backplane (2).
3. Lift the module up and away from the backplane to disengage the pivot hook (3).

Figure 2: Removing a Module



How to Avoid Damage When Reinstalling Modules

NOTICE

Be careful not to bend or break the pins on the back of the module!

These modules are designed with male pins that should easily slide into the female port on the backplane. The pins must be perfectly aligned, though, or they will bend or break when pushed in. Follow the guidelines in Figure 3 and the procedure on page 7 to properly install the modules.



If you receive unexplained errors later in the procedure, check the condition of these pins. If they are bent, try straightening them and re-installing the module. If they are broken off or pushed in, call MiTek Customer Service to return the current module and obtain a new one.

Figure 3: Avoiding Damage When Re-Installing

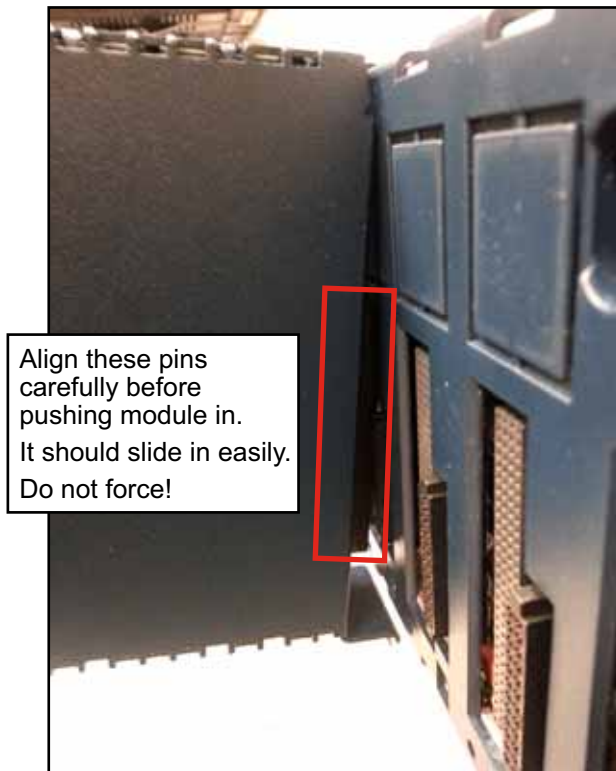

Installing Modules Overview

To install modules discussed in this Service Bulletin, use the applicable procedure below and follow the guidelines given in Figure 3.

Pivot-Hook Modules

1. Holding the module firmly, align the module with the correct slot and connector.
2. Engage the module's rear pivot hook(s) in the notch(es) on the top of the backplane (1)
3. Swing the module down (2) until the module's connector engages the backplane's connector, and the release lever(s) on the bottom of the module snaps into place in the bottom module retainer (3).

Figure 4: Installing a Pivot-Hook Module

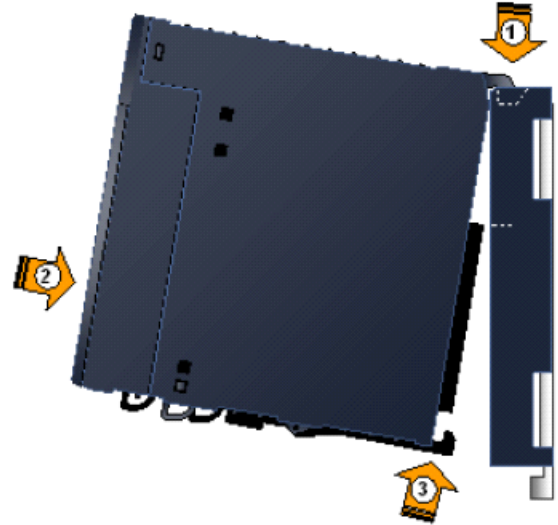

Ensure the pins are aligned as described on page 6!

4. Visually inspect the module to be sure it is properly seated.

Screw-In CPU/Modules

1. Holding the module firmly, align the module with the correct slot and connector.
2. Engage the module's rear pivot hook(s) in the notch(es) on the top of the backplane (1).
3. Gently press the module pins into the connector holes (2). Ensure the pins are aligned as described on page 6!
4. Attach the bracket at the bottom of the module (3) to the bracket on the backplane with 2 screws.

Figure 5: Installing a Screw-In CPU

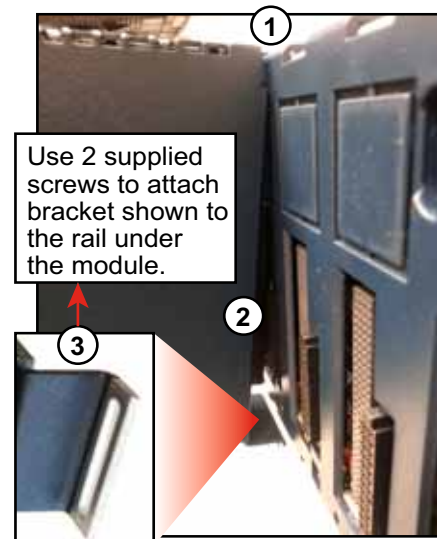

Removing the Old Backplane



1. Open the electrical enclosure and locate the PLC shown in Figure 6.

Figure 6: Locating the PLC



2. Label the input and output modules shown in Figure 7 using tape and a permanent marker.
3. Remove components from the backplane behind the PLC using the following steps.

Figure 7: Labeling Modules



- a) Use a screwdriver to remove the wiring on the left-hand side of the power supply that is labeled in Figure 6.
- b) Remove the power supply module.
- c) Remove the CPU module.
- d) Remove the communication module:
 - 1) Remove the cover as shown in Figure 8.
 - 2) Remove the screw holding the cable, and remove the cable.
 - 3) Remove the communication module from the backplane.

Figure 8: Removing the Cover



- e) Remove the input and output modules from the backplane. Refer to Figure 7 again to see modules if necessary. The modules will stay wired. Let them lie on the wireway until ready to place them on the backplane again.
- f) Remove the backplane by removing the 4 screws shown in Figure 10 with a Phillips-head screwdriver.

Figure 9: Removing the Backplane



- g) Place the new backplane and tighten the 4 screws. The new backplane should fit the space the old backplane occupied. Drilling should not be required.

Figure 10: Placing the New Backplane



Installing the New Components

1. Place PLC components onto the new backplane by using the following steps and referring to Figure 11.

Figure 11: Slots and Components on New Backplane

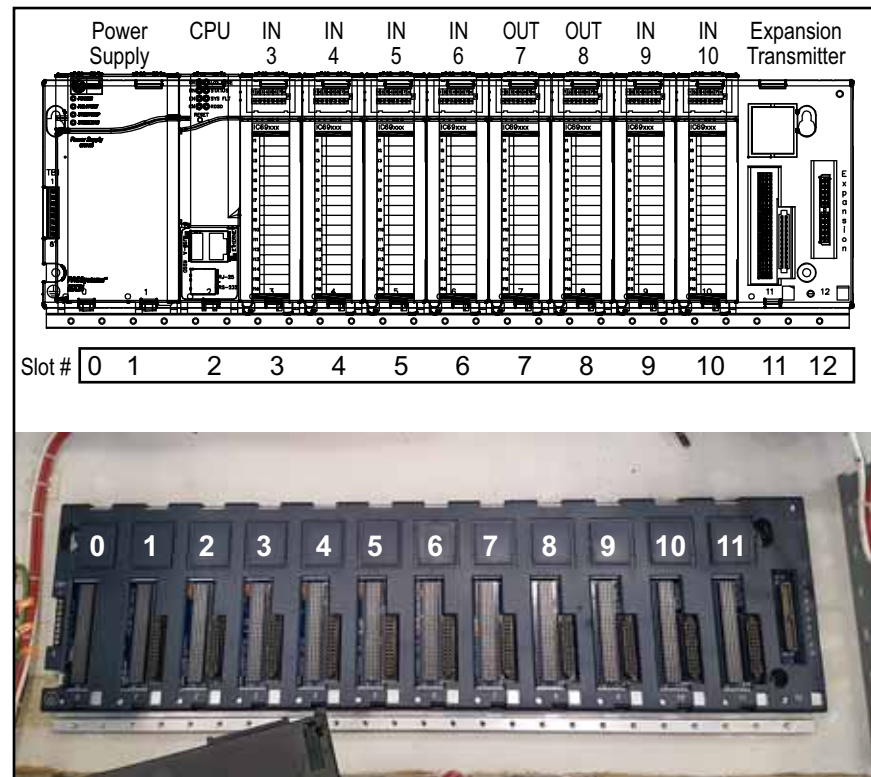

- a) Place the new power supply in slots #0 and #1.
- b) Check the rear of the CPU. If a yellow tab is attached to the CPU, pull it free carefully without removing the battery. See Figure 12. Place the CPU into slot #2.

Figure 12: Remove Tag From CPU



- c) Attach the energy pack to the left-hand side power supply, and connect the energy pack to the CPU using the black cable with white connectors. These connectors snap into the bottom of the energy pack and the CPU as shown in Figure 13. The energy pack does not connect directly to the backplane.

Figure 13: Connecting the Energy Pack With the CPU

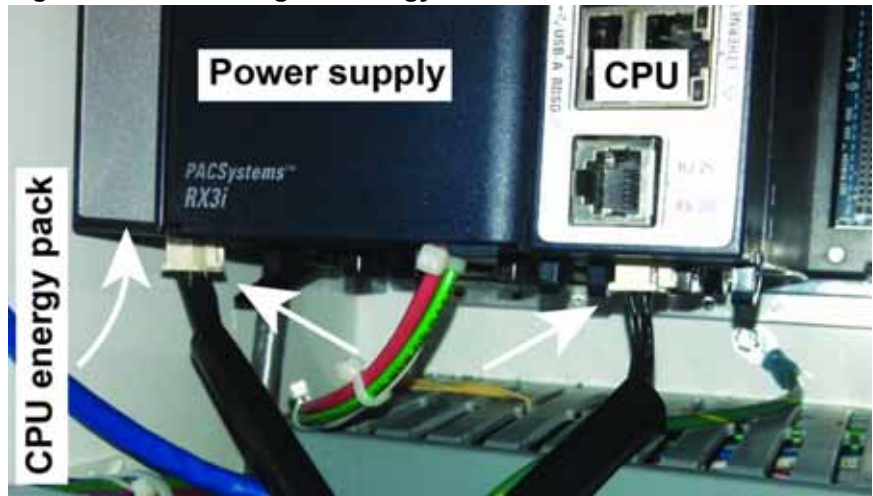

- d) Reconnect the red, white, and green wires to the power supply.
- e) Snap the yellow Ethernet cable into the CPU as shown in Figure 14. The cable will not connect at its other end yet.
- f) Place the input and output modules back on the backplane. Refer to Figure 11.
 - 1) Install module #1 in slot #3.
 - 2) Install module #2 in slot #4.
 - 3) Continue until all modules are installed on the backplane. The backplane is now reassembled.
- g) See Figure 15 to confirm that the backplane is properly assembled.

Figure 14: Inserting the Ethernet Cable



Figure 15: Checking the PLC



Installing New Touch Screen Power and Ethernet Switch

1. Locate the circuit breakers on the DIN rail to the right of the backplane as shown in Figure 16. Slide all of the circuit breakers to the left. This should leave more space on the DIN rail to the right of the breakers.

Figure 16: Shifting the Circuit Breakers

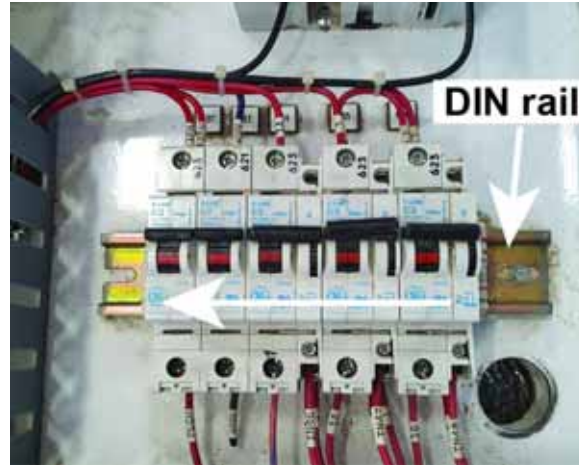

2. Mount the Ethernet switch on the DIN rail to the right of the circuit breakers. Mount the 24V power supply to the right of the Ethernet switch, as shown in Figure 17.

Figure 17: Mounting 24V Power Supply

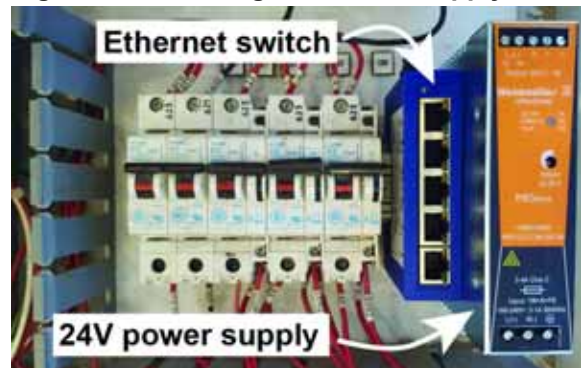

3. Connect wires and cables to the 24V power supply and Ethernet switch using the following directions.
 - a) Loosen the screws on the second circuit breaker from the left (it is the only 1-amp circuit breaker on the DIN rail). Remove the blue wires from the second circuit breaker. Replace them with red 16-gauge wire. See Figure 18.

Figure 18: Wiring the 24V Power Supply

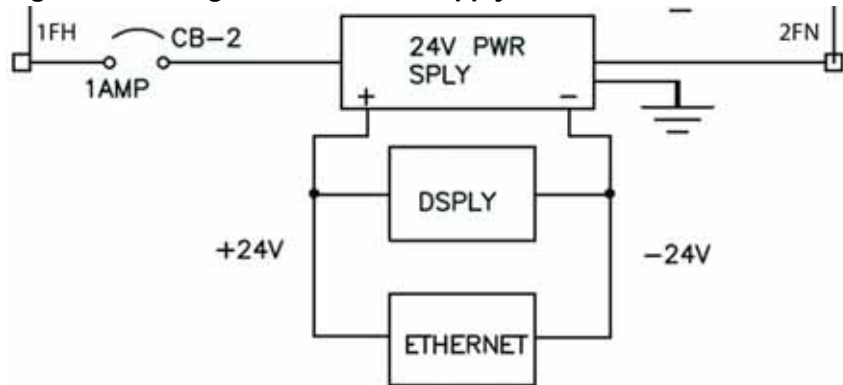

- b) Wire the 24V power supply and the Ethernet switch with blue wires.
- c) Insert the yellow Ethernet cable from the CPU on the backplane into the top slot on the Ethernet switch. See Figure 19.
- d) Insert the white Ethernet cable into the slot underneath the yellow Ethernet cable. Leave the other end of the white Ethernet cable lying near the display. It will connect later.

Figure 19: Yellow Cable Entering the Ethernet Switch



Replacing the Touch Screen Monitor

1. Locate the old touch screen monitor on the enclosure door, as shown in Figure 20.

Figure 20: Replacing the Old Touch Screen Monitor



2. Disconnect the touch screen monitor using these steps:
 - a) Disconnect the wires on the left-hand side of the touch screen monitor.
 - b) Disconnect the old communication cable from the right-hand side.
 - c) Remove the four bolts holding the old touch screen monitor into place.
3. Install the new touch screen monitor using these steps:
 - a) Use a jigsaw to enlarge the hole to 7-1/4" W x 5-1/16" H so that the new touch screen monitor fits. Note that the existing hole can be expanded to the left, right, or top. It cannot expand downward because of the rib on the panel door.
 - b) Connect the white Ethernet cable to port on the bottom of the touch screen monitor. See Figure 20. The other end of the cable should already be inserted in the second-highest slot on the Ethernet switch.
 - c) Connect the blue and white wires from the 24V power supply to the bottom of the touch screen monitor.

Completing the PLC Upgrade

1. Check the power supply on the backplane to ensure that its switch is turned to the on position.
2. Close the enclosure door and turn the disconnect handle On.
3. Remove the lockout/tagout devices from the wall panel.
4. Check the lights on the PLC to determine if the system is functioning correctly, as shown in Figure 21. If the system is not working, see Table 3 included at the end of this Service Bulletin for more information.

Figure 21: Checking PLC Indicator Lights



5. Check the touch screen computer to ensure that it has power and responds to the touch.

Overview of PLC Indicators

Review and become familiar with the CPU and RDS D indicators in Table 3.

Table 3: Explanation of PLC CPU Indicators (for model CPE305)

LED Name	LED State	CPU Operating State
OK	On, green	CPU has passed its power up diagnostics and is functioning properly (after initialization is complete).
	Off	CPU problem. RUN and OUTPUTS ENABLED LEDs may be blinking in an error code pattern, which can be used by technical support for troubleshooting.
	Blinking, other LEDs off	CPU in Stop-Halt state; possible watchdog timer fault. Refer to the fault tables. If the programmer cannot connect, cycle power and refer to fault tables in PLC manufacturer's manual.
OK and EN (both)	Blinking in unison	CPU is in boot mode and is waiting for a firmware update through a serial port.
RN	On	CPU is in Run mode.
	Off	CPU is in Stop mode.
EN	On	Output scan is enabled.
	Off	Output scan is disabled.
I/O FORCE	On	Override is active on a bit reference.
STATUS	Blinking, green	Energy Pack charging; not yet charged above the minimum operating voltage. (It can operate while below minimum charge because the energy pack is not in use.)
	On, red	Energy Pack circuit fault. There is no need to replace the energy pack because the PLC works without it.
	Blinking, red	Energy Pack near its end of life. There is NO need to replace because the PLC receives its power from the saw.
	On, green	Energy Pack is charged above its minimum operating voltage.
	Off	Energy Pack not connected. Connect the cable to the PLC.
SYS FLT (System Fault)	On, red	CPU is in Stop/Faulted mode because a fatal fault has occurred.
CM	Blinking, green	Signal activity on COM1 port.
	Off	No activity on COM1 port.

END OF SERVICE BULLETIN