

Service Bulletin

Machinery Affected: BLADE™ Saw
Document: SB209
Title: Replacing the Linear Guide Bearings
Applies To: Replacing the Cartridge Version
With the Grease Fitting Version
Distribution: Upon Order



Copyright © 2014 MiTek®. All rights reserved.

MiTek Machinery Division
301 Fountain Lakes Industrial Drive
St. Charles, MO 63301
Phone: 800-523-3380
www.mii.com

Item # and Rev.	SB209 rev. A
Revision Date	28 June 2016
Revised By	R. Tucker
Approved By	R. Tucker
Applicability	
Effectivity	saws made prior to January 2015

Purpose and Scope



Purchase the grease described on page 3 before starting this procedure!

When replacing the linear guide bearings, use the parts and instructions in this kit. Maintaining the new bearings may differ from your previous bearings, so read these instructions through to the end.

The term *previously used* in this document refers to the bearing blocks that contained a reservoir cartridge instead of the grease fitting used on these bearings. These new bearings have a different part number, but are a direct replacement for the previously used bearings.

Equipment Manuals with revision A or higher on the title page include these instructions. If your manual does not include these instructions, keep this Service Bulletin for maintenance purposes.

Overview

This SB is part of Service Bulletin kit SB209KIT-A and SB209KIT-B. The parts included in this kit are shown in Table 1. Please ensure all parts are present before starting this procedure.

Table 1: Parts in SB209 Kits

Qty.	Part Description	Part #	Applicable Kit	Grease (not supplied)
1	Linear bearing block (includes the block insert and grease fitting)	416103	SB209KIT-A (size 25) for LASM, Stroke, & Elevation	0.8 cm ³
		OR 416104	SB209KIT-B (size 20) for Gripper, Infeed Top Clamp, Infeed Side Clamp, and Outfeed Clamp	0.5 cm ³
1	Service Bulletin	SB209	Both kits	

Before beginning the procedure, gather the supplies listed in Table 2.

Table 2: Customer-Supplied Items

Qty.	Part Description
1	Metric set of Allen wrenches
1	Grease described on page 3
1	Grease gun described on page 3
1	Lockout/tagout mechanisms

If you have any questions, call MiTek Machinery Division Customer Service at 800-523-3380.

Grease Required

Mobilux™ EP 2

This is a general purpose, lithium-based Grade 2 grease that provides excellent protection against rust and corrosion and resist water wash-out, corrosion protection, low temperature pumpability, and high temperature service life.

	NOTICE
	<p>Other Grade 2 greases will not provide the necessary properties at the high temperatures experienced in this application. Use only the recommended grease.</p>

Grease Gun Recommended

It is recommended to use the following grease gun to ensure the proper amount of grease is applied. If you do not have this grease gun available for this procedure, it is recommended that you purchase one for future use. These bearings will require re-greasing at frequent intervals. Having a policy stating the grease gun and number of pumps to use on each bearing will elongate their life and the accuracy of the saw.

Hiwin GN-80M
 Output: 0.5-0.6 cm³ per stroke

If you choose to use a different grease gun, document which gun is to be used for this procedure and ensure employees know the output per stroke. The output per stroke should be equal to or less than 0.5 cm³ per stroke.

Modifying Your Grease Gun

It may be difficult to fit the grease gun tip onto the bearing fitting due to limited space around the bearing. To make the greasing process easier, grind down a flat spot on one side of the grease gun tip or machine the outside diameter (O.D.) of the tip down so it fits into the space around the bearing fitting. The outside diameter is shown in Figure 1.

Figure 1: Grease Gun Tip





This requirement makes it that much more important to have a grease gun dedicated for this procedure.

Procedure





Electrical Lockout/Tagout Procedures

	 WARNING
	<p>ELECTROCUTION HAZARD!</p> <p>Verify that all power to the machine has been turned off and follow approved lockout/tagout safety procedures before performing any maintenance.</p> <p>All electrical work must be performed by a qualified electrician.</p> <p>If it is absolutely necessary to troubleshoot an energized machine, follow NFPA 70E for proper procedures and personal protective equipment.</p>

When Working on a Machine Outside the Machine’s Main Electrical Enclosure

Before performing maintenance on any machine with electrical power, lockout/tagout the machine properly. When working on a machine outside of the machine’s main electrical enclosure, not including work on the electrical transmission line to the machine, follow your company’s approved lockout/tagout procedures which should include, but are not limited to the steps here.

1. Engage an E-stop on the machine.
2. Turn the disconnect switch handle on the machine’s main electrical enclosure to the “off” position. See Figure 2.



	 WARNING
	<p>ELECTROCUTION HAZARD.</p> <p>When the disconnect switch is off, there is still live power within the disconnect switch’s enclosure. Always turn off power at the building’s power source to the equipment before opening this electrical enclosure!</p>

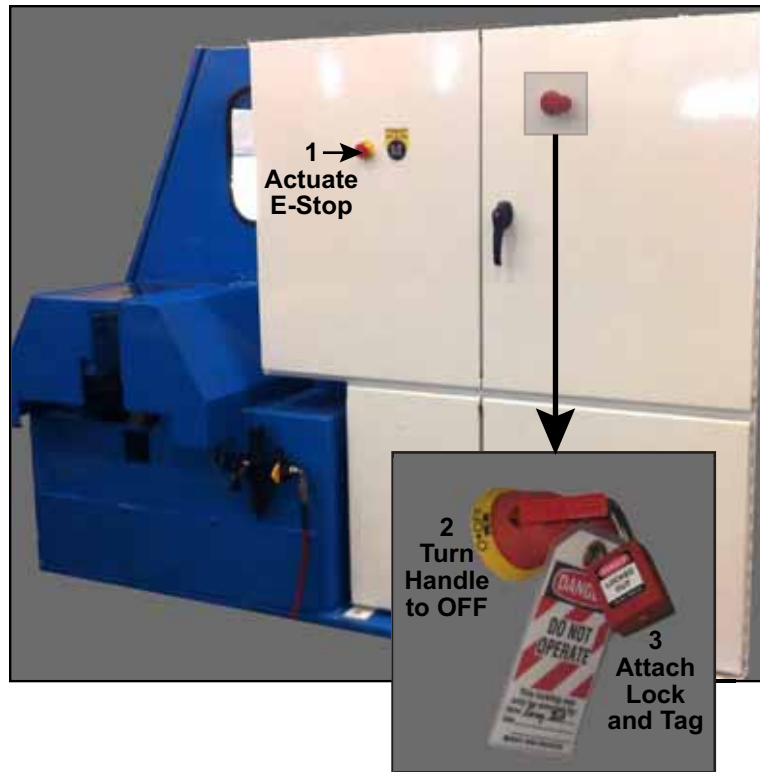

3. Attach a lock and tag that meets OSHA requirements for lockout/tagout.

Figure 2: Lockout/Tagout on the Main Electrical Enclosure



Pneumatic System Lockout/Tagout Procedure

	 WARNING
	<p>MOVING PARTS CAN CRUSH AND CUT.</p> <p>Always verify that power to the machine has been turned off and follow approved lockout/tagout procedures.</p> <p>Turn off the air switch before performing any maintenance on the equipment.</p>

	 WARNING
	<p>HIGH PRESSURE HAZARD.</p> <p>Bleed pneumatic lines before performing any maintenance on the pneumatic system.</p>

Bearing Locations

Note: the Gripper bearings are not shown.

Figure 3: Bearing Locations for Stroke and Elevation

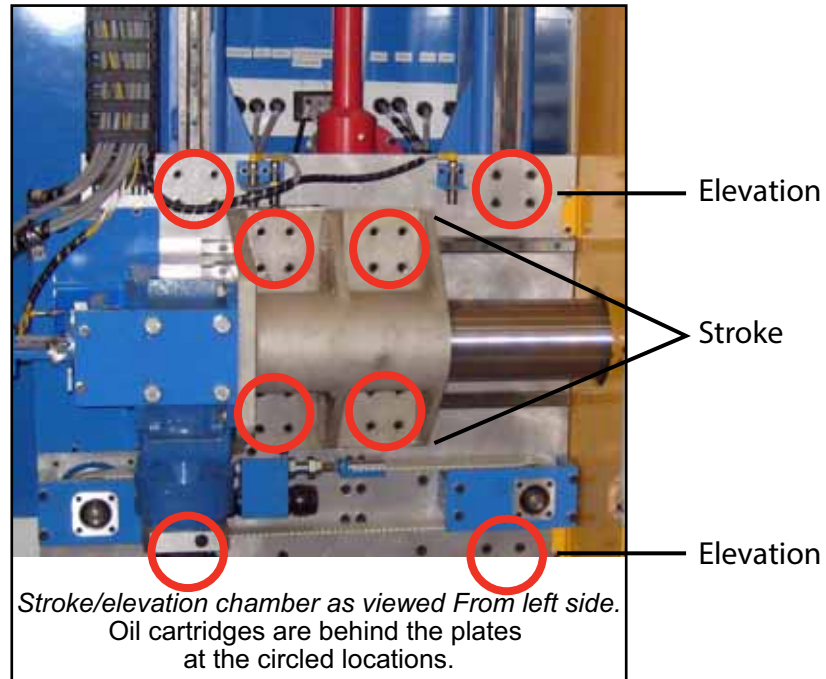

Figure 4: Bearing Locations for LASM

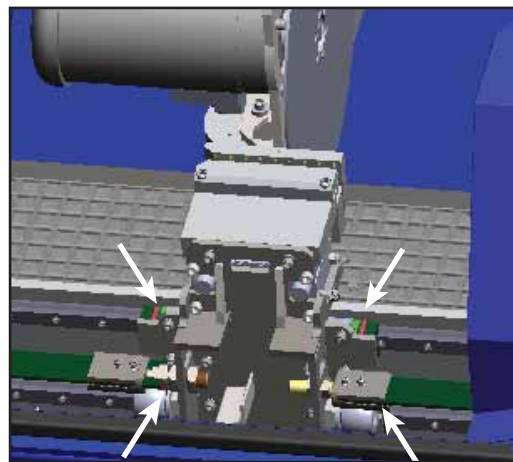

Figure 5: Bearing Locations for Infeed Side and Top Clams

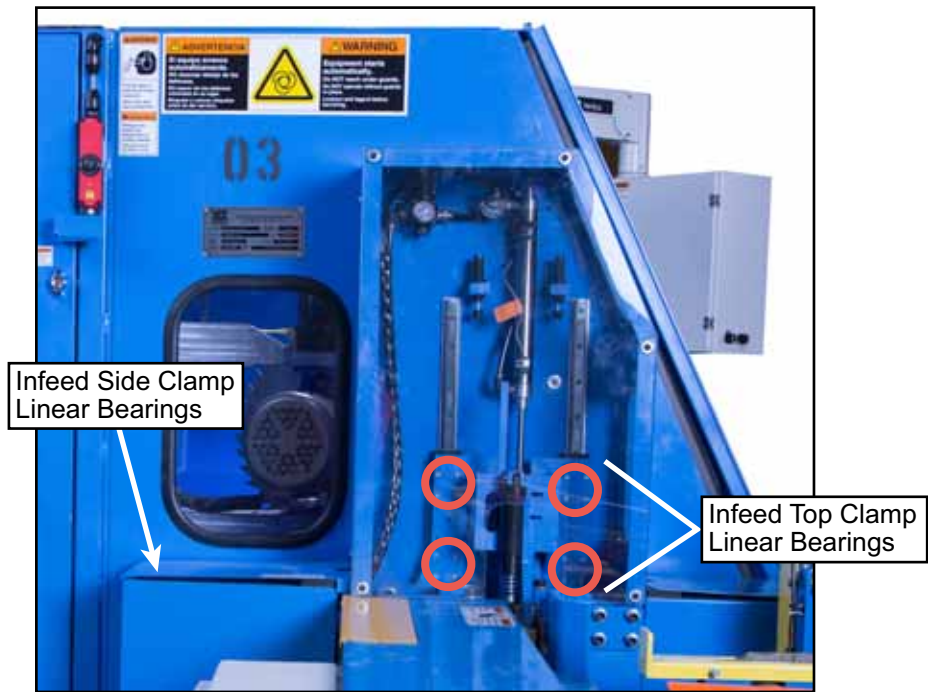
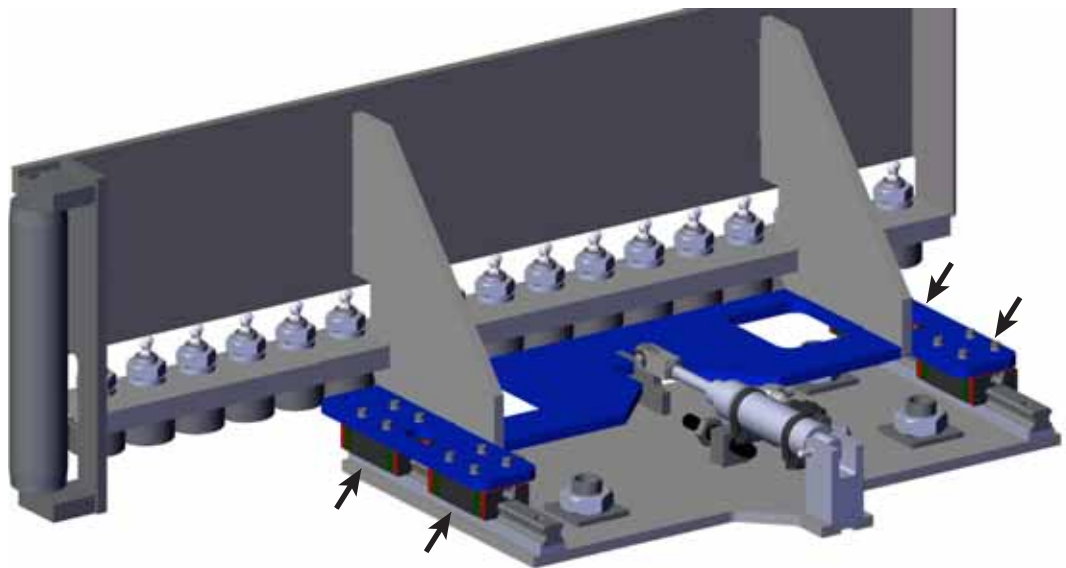

Figure 6: Bearing Locations for Outfeed Clamp



Replacing a Bearing Block



Figure 3 and Figure 5 on page 6 show some of the bearing locations.

1. After locking/tagout out, remove the previously used bearing block:
 - a) Unscrew the 4 screws from the plate. Keep the screws to use later.
 - b) Slide the bearing off of the rail. Be sure to keep the bearing level to prevent the ball bearings from falling out.
2. Discard the previously used bearing, but NOT the screws.
3. Examine the new bearing block. The grease fitting must be securely attached to the bearing block. If it is loose in the box, connect it using these steps:
 - a) Clean dust, metal shavings, and oil off the hole threads. Use a standard brake cleaner or anything that removes lubrication.
 - b) Screw the fitting into the bearing block as shown in Figure 7. Ensure the fitting is facing a direction that allows it to be easily accessed later. The direction the fitting should face depends on its location on the saw, so visualize its location carefully before installing the fitting.

Figure 7: Important Parts of Each Bearing Block

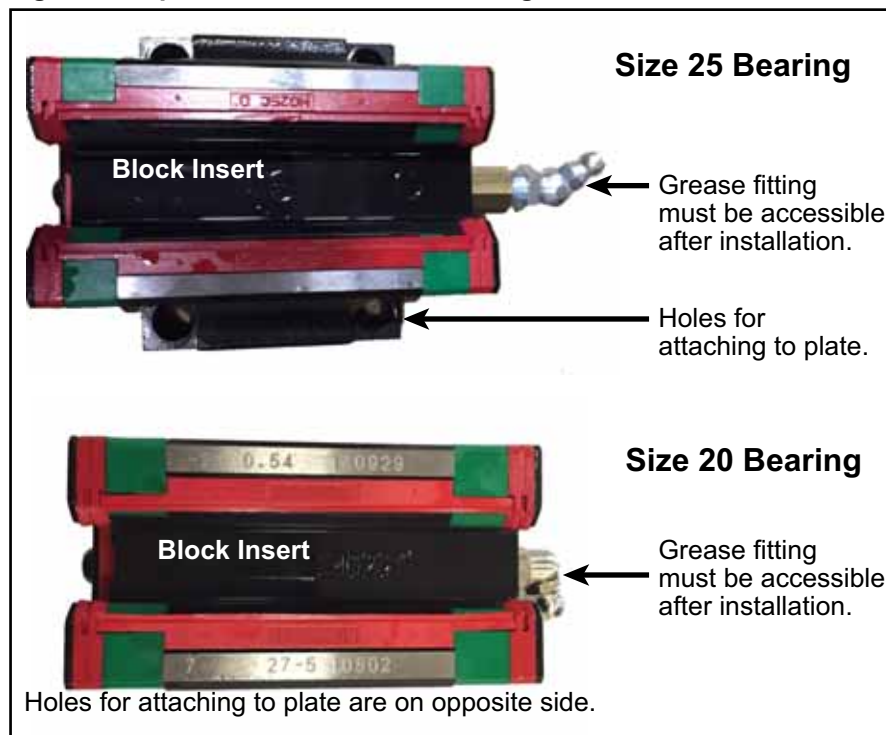

4. Clean oil and debris off of the parts listed below. A standard brake cleaner or anything that removes lubrication will work.
 - a) On the new bearing, with the block insert in place to protect the ball bearings, carefully clean the threaded screw holes. Do not get cleaner in the ball bearing area.
 - b) Clean the screws that were removed from the old bearing block.
5. Install the new bearing block, with the fitting facing out, so it will be accessible to grease in the future.
 - a) Slide the bearing block onto its rail, allowing the rail to push the block insert completely out of the bearing block.
 - b) Slide the bearing block down until it is behind the linear guide plate and the holes are aligned.
 - c) Using the screws removed from the previously used bearing block, apply blue *Loctite*TM thread adhesive to each screw and screw the plate and bearing block together.
 - d) Wait 10 minutes for the *Loctite* thread adhesive to dry before moving the assembly.



Make sure the grease fitting is pointing out, so it is easily accessible.

NOTICE	
	<p>Use <i>Loctite</i> thread adhesive to prevent the bearings from coming loose, causing costly machine damage.</p> <p>The bearings are shipped with NO grease in them. They MUST be greased before operating the saw!</p>

6. After the *Loctite* thread adhesive is dry, apply the correct amount of grease to the fitting.
 - The grease volume is listed in Table 1 on page 2.
 - The correct grease is specified on page 3.
 - The grease gun recommended is described on page 3.



Overgreasing will cause premature failure of bearing seals and excessive saw dust and dirt to stick to the guide rails, negating the benefits of the grease. Undergreasing may cause damage to components and affect the accuracy of the saw. A thin film of grease should be visible on the guide rails at all times.

7. Remove the lockout/tagout mechanisms.
8. Run the saw, then lockout/tagout again and look at the rail. Check to see if a lubricant film can be seen on the rail. If not, add more grease.



Maintaining the New Bearings

Check the quality of the lubrication on the guide rails every week to determine when more grease is needed. The frequency of greasing depends on many factors including amount of use and amount of dust. After enough time has passed to determine a pattern, document how often the bearings should be greased, but continue to inspect the rails every week.

Linear rails using the previously used bearing blocks (that have a reservoir cartridge instead of a grease fitting) should also be inspected each week. Follow the instructions in the Maintenance Manual for lubricating those bearings.

For re-greasing the new bearings with the grease fitting:

- Use the same volume of grease that is listed in Table 1 on page 2.
- It is highly recommended to either use the grease gun recommended on page 3 or to create an internal procedure stating the exact grease gun that should be used and how many times to pump the gun handle to administer the correct volume of grease.

Equipment Manuals with revision A or higher on the title page include these instructions. If your manual does not include these instructions, keep this Service Bulletin for maintenance purposes.

NOTICE	
	<p>Add grease to these new bearings periodically to ensure saw accuracy and prevent friction from damaging components.</p> <p>Overgreasing will cause premature failure of bearing seals and excessive saw dust and dirt to stick to the guide rails, negating the benefits of the grease. Undergreasing may cause damage to components and affect the accuracy of the saw. A thin film of grease should be visible on the guide rails at all times.</p>

END OF SERVICE BULLETIN